



# DEAD WEIGHTS MICRO AND MACRO-HARDNESS OFFER





## THE FINAL STEP OF THE PROCESS.

PRESI offers a new vision of hardness with its complete range of micro and macro-hardness testers with dead weights.

For the examination of your samples and the determination of the material characteristics, we design top of the range equipment. They guarantee perfectly reliable and repeatable results.

Thanks to our scalable hardware and software solutions, we can cover the whole range, up to the highly specialised needs.

**A complete vision,  
without compromise.**

# MAKE THE RIGHT CHOICE

## INDENTER TYPE

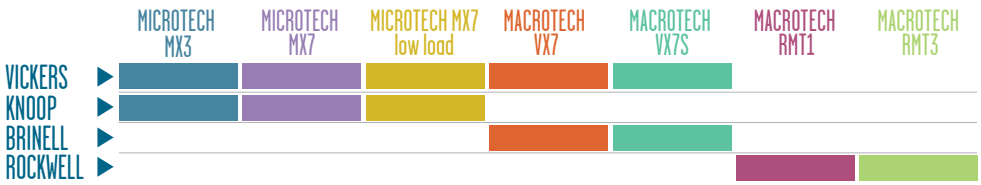

## LOAD RANGE

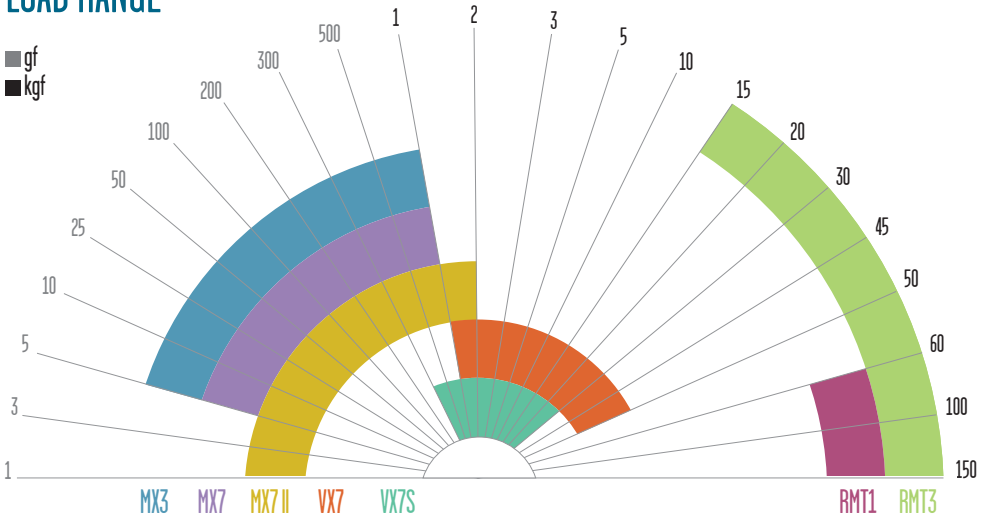

## NUMBER OF TURRET POSITIONS

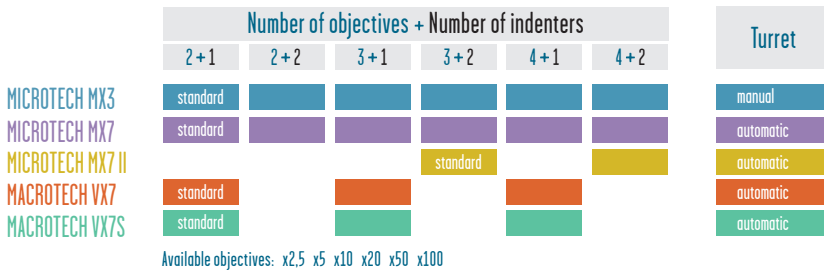

## UPGRADABILITY - PACK VIEW ▶ PACK TOUCH MANUAL ▶ PACK TOUCH SEMI-AUTO

	PACK PRESI		
	View Hardness	Touch Manual	Touch Semi-auto
<b>INDENTATION TYPE</b>			
Single indents	●	●	●
Manual pattern		●	
Semi-automatic pattern			●
<b>EQUIPMENT</b>			
Multilingual software for measurement and image analysis	●	●	●
USB2 digital camera, 1.3M pixels	●	●	●
Automatic light		●	●
Turret control		●	●
Motorized stage and joystick			●
Control box			●
<b>FEATURES</b>			
Manual or automatic measurement	●	●	●
Automatic storage of results and photos	●	●	●
Pattern settings		●	●
Hardness tester / PC communication		●	●
Overview			●
Alerts for measurement errors and load differences		●	●
Analysis reports		●	●

# MICROTECH MX3

Ref. 71116

The Vickers MX3 hardness tester with manual turret offers a complete solution in order to meet the needs of quality laboratories, as well as on-line controls.



- Manual turret up to 6 positions.
- Vickers and Knoop hardness.
- Automatic load application.
- High-rigidity frame.

## UPGRADABILITY

PACK PRESI  
View Hardness



PACK PRESI  
Touch Manual



PACK PRESI  
Touch Semi-auto

## LOAD RANGE (gf)



## TECHNICAL FEATURES

	Standard	Option
Manual turret	2 objectives x10 x50 1 Vickers indenter	Up to 4 objectives including x10 and x50, 1 Vickers indenter and 1 Knoop indenter
Load application	Automatic load application	-
Indentation time	5 to 99s	-
Precision	0.01µm (x200 - x1000)	-
Magnification	x100 - x500	x25 - x1000
Max. measurable length	200µm	-
Data output	RS 232C output	-
Memory	999 max. memorized measurements	-
Conversions	Conversion to other scales according to SAE (J-417B), ASTM (E-140)	-
Max. sample height	120mm	-
Power supply	240V 50/60Hz	-
Touchscreen	LCD display with backlight	-
Visualisation/Measurement	Direct measurement in the eyepiece and results display	-
Lighting	LED	-

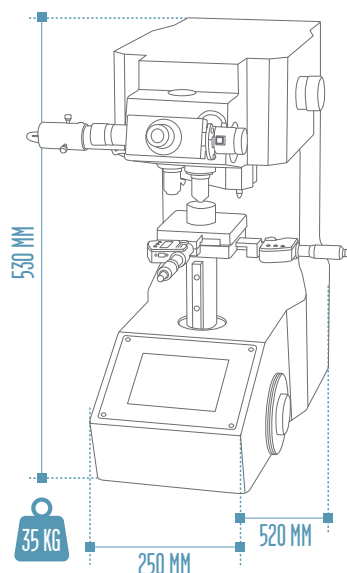

## AVAILABLE OPTIONS



Ref. 71164



Ref. 71134



Ref. 71106



Ref. 71133



Ref. 71157



Ref. 71109



Ref. 71175



Ref. 71176



Ref. 71174



Ref. 71108



Ref. 71113



Ref. 71503



Ref. 71120

### Indenters

71164 VICKERS

71134 KNOOP

### Objectives

71106 x2.5

71154 x5

71142 x10

71129 x20

71143 x50

71135 x100

### Turret

71131 3-position turret for objectives

71130 4-position turret for objectives

71115 2 indenter Knoop and Vickers

### Standard vices

71133 50mm opening

71199 100mm opening

### Sample holders and removable holders

71157 Sample holder for non-mounted samples

71109 Single place sample holder

71175 Sample holder 4 places

71176 Sample holder 6 places

71174 Removable holder ø 25mm

71144 Removable holder ø 25.4mm

71110 Removable holder ø 30mm

71111 Removable holder ø 31.7mm

71145 Removable holder ø 38.1mm

71125 Removable holder ø 40mm

71173 Removable holder ø 50mm

### Other accessories

71108 C Mount for Microtech

71113 Standard Vickers test block ø 30mm x 10mm for Microtech

71503 Object micrometer

71120 Digital micrometers for manual XY stage



# MICROTECH MX7

## MICROTECH MX7 LOW LOADS

Ref. 71114 Ref. 71105

The Vickers MX7 and MX7 low load hardness testers with automatic turret offer a complete solution in order to meet the needs of quality laboratories, as well as on-line controls.



- Automatic turret up to 6 positions.
- Vickers and Knoop hardness.
- Automatic load application.
- High-rigidity frame.

UPGRADABILITY

PACK PRESI  
View Hardness



PACK PRESI  
Touch Manual



PACK PRESI  
Touch Semi-auto

## LOAD RANGE (gf)

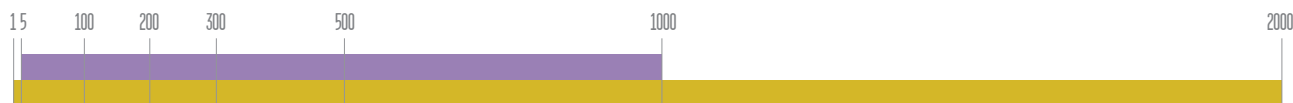

## TECHNICAL FEATURES

	MX7	MX7 low load
<b>Automatic turret</b>	2 objectives x10 x50 1 Vickers indenter	3 objectives x10 x50 x100 1 Vickers indenter + 1 Knoop indenter
<b>Turret options</b>	Up to 4 objectives including x10 x50 + 2 indenters	Up to 4 objectives including x10 x50 x100
<b>Load application</b>	Automatic load application	Automatic load application
<b>Load application speed</b>	50µm/s	50µm/s
<b>Indentation time</b>	5 to 99s	5 to 99s
<b>Precision</b>	0,1µm (x200 - x1000)	0,1µm (x200 - x1000)
<b>Magnification</b>	x100 - x500	x100 - x500 - x1000
<b>Max. measurable length</b>	200µm	200µm
<b>Data output</b>	RS 232C output	RS 232C output
<b>Memory</b>	999 max. memorized measurements	999 max. memorized measurements
<b>Conversions</b>	Conversion to other scales according to SAE (J-417B), ASTM (E-140)	Conversion to other scales according to SAE (J-417B), ASTM (E-140)
<b>Max. sample height</b>	120mm	120mm
<b>Power supply</b>	240V 50/60Hz	240V 50/60Hz
<b>Touchscreen</b>	LCD display with backlight	LCD display with backlight
<b>Lighting</b>	LED	LED

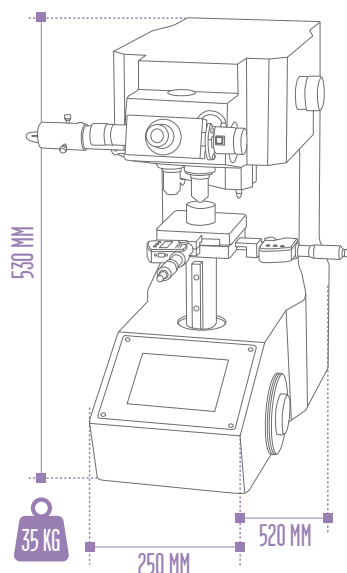

## AVAILABLE OPTIONS



Ref. 71164



Ref. 71134



Ref. 71106



Ref. 71133



Ref. 71157



Ref. 71109



Ref. 71175



Ref. 71176



Ref. 71174



Ref. 71108



Ref. 71113



Ref. 71503



Ref. 71120

### Indenters

71164 VICKERS

71134 KNOOP

### Objectives

71106 x2.5

71154 x5

71142 x10

71129 x20

71143 x50

71135 x100

### Turret

71131 3-position turret for objectives

71130 4-position turret for objectives

71115 2 indenter Knoop and Vickers

### Standard vices

71133 50mm opening

71199 100mm opening

### Sample holders and removable holders

71157 Sample holder for non-mounted samples

71109 Single place sample holder

71175 Sample holder 4 places

71176 Sample holder 6 places

71174 Removable holder ø 25mm

71144 Removable holder ø 25.4mm

71110 Removable holder ø 30mm

71111 Removable holder ø 31.7mm

71145 Removable holder ø 38.1mm

71125 Removable holder ø 40mm

71173 Removable holder ø 50mm

### Other accessories

71108 C Mount for Microtech

71113 Standard Vickers test block ø 30mm x 10mm for Microtech

71503 Object micrometer

71120 Digital micrometers for manual XY stage

# MACROTECH VX7 MACROTECH VX7S

Ref. 71124 Ref. 71132

The Vickers VX7 and VX7S hardness testers and semi-macro hardness testers with automatic turret offer complete solution to meet the needs of quality laboratories, as well as production line controls.



- 5-position automatic turret.
- Touchscreen.
- Hardness Vickers, Knoop and Brinell.
- Automatic load application.
- High-rigidity frame.

UPGRADABILITY

PACK PRESI  
View Hardness



PACK PRESI  
Touch Manual



PACK PRESI  
Touch Semi-auto



## LOAD RANGE (kgf)



## TECHNICAL FEATURES

	VX7	VX7S
<b>Automatic turret</b>	2 objectives x10 x20, 1 Vickers indenter	2 objectives x10 x20, 1 Vickers indenter
<b>Options turret</b>	Up to 4 objectives including x10 x20 + 1 indenter	Up to 4 objectives including x10 x20 + 1 indenter
<b>Load application</b>	Automatic load application	Automatic load application
<b>Load application speed</b>	85µm/s	85µm/s
<b>Indentation time</b>	5 to 99s	5 to 99s
<b>Precision</b>	In accordance with ISO 6507-2, JIS B7725, ASTM (E-384) standards	In accordance with ISO 6507-2, JIS B7725, ASTM (E-384) standards
<b>Magnification</b>	x100, x200	x100 - x200
<b>Max. measurable length</b>	999.9µm - 600µm	999.9µm - 600µm
<b>Data output</b>	RS 232C output	RS 232C output
<b>Memory</b>	999 max. memorized measurements	999 max. memorized measurements
<b>Conversions</b>	Conversion to other scales according to ASTM (E-140) et JIS	Conversion to other scales according to ASTM (E-140) et JIS
<b>Max. sample height</b>	250mm	250mm
<b>Max. sample length</b>	150mm	150mm
<b>Power supply</b>	240V 50/60Hz	240V 50/60Hz
<b>Touchscreen</b>	LCD display with backlight	LCD display with backlight
<b>Lighting</b>	LED	LED

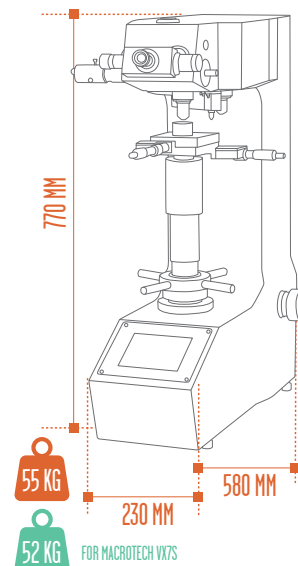

## AVAILABLE OPTIONS



Ref. 71165



Ref. 71156



Ref. 71106



Ref. 71133



Ref. 71157



Ref. 71109



Ref. 71175



Ref. 71176



Ref. 71174



Ref. 71128



Ref. 71141



Ref. 71503



Ref. 71120

### Indenters

71165	VICKERS
71156	BRINELL

### Objectives

71106	x2.5
71154	x5
71142	x10
71129	x20
71143	x50
71135	x100

### Turret

71131	3-position turret for objectives
71130	4-position turret for objectives

### Standard vices

71133	50mm opening
71199	100mm opening

### Sample holders and removable holders

71157	Sample holder for non-mounted samples
71109	Single place sample holder
71175	Sample holder 4 places
71176	Sample holder 6 places
71174	Removable holder ø 25mm
71144	Removable holder ø 25.4mm
71110	Removable holder ø 30mm
71111	Removable holder ø 31.7mm
71145	Removable holder ø 38.1mm
71125	Removable holder ø 40mm
71173	Removable holder ø 50mm

### Other accessories

71128	Video output + C mount
71141	Standard Vickers test block ø 64 x 15mm
71503	Object micrometer
71120	Digital micrometers for manual XY stage
71121	Stage adapter for ref. 71122 & 71152
71122	Manual XY stage 25 x 25mm movement

# MACROTECH RMT1

# MACROTECH RMT3

Ref. 71199

Ref. 71117

Rockwell RMT1 and RMT3 hardness testers cover all scales in order to meet the needs of quality laboratories, as well as controls on the production line.



- Automatic indent.
- Direct digital reading.
- Assisted pre-charge.
- Very easy settings.
- New LCD screen.

## LOAD RANGE (kgf)



## TECHNICAL FEATURES

	MACROTECH RMT1	MACROTECH RMT3
<b>Preload mode</b>	Assisted preload (LCD Visual and BIP sound)	Assisted preload (LCD Visual and BIP sound)
<b>Load application</b>	Automatic	Automatic
<b>Starting cycle</b>	Automatic start / Possible in manual	Automatic start / Possible in manual
<b>Indentation time</b>	3 to 99s	3 to 99s
<b>Measurements on plastics</b>	Standard	Standard
<b>Measurement scales</b>	C D A G B F K E H P M L V S R	15N 30N 45N 15T 30T 45T 15W 30W 45W 15X 30X 45X 15Y 30Y 45Y C D A G B F K E H P M L V S R
<b>Data output</b>	RS 232C output	RS 232C output
<b>Memory</b>	999 max. memorized measurements	999 max. memorized measurements
<b>Conversions</b>	In accordance with SAE J417b, ASTM E 140 standards	In accordance with SAE J417b, ASTM E 140 standards
<b>Precision</b>	In accordance with JIS B7726, ASTM (E-18) standards	In accordance with JIS B7726, ASTM (E-18) standards
<b>Max. sample height</b>	200mm	200mm
<b>Max. depth piece</b>	165mm	165mm
<b>Alimentation</b>	240V 50/60Hz	240V 50/60Hz
<b>Touchscreen</b>	LCD display with backlight	LCD display with backlight

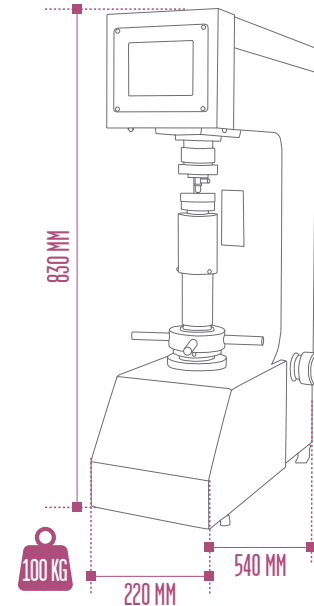

## AVAILABLE ACCESSORIES



Ref. 71199



Ref. 71199

Ball indenter	Diam 1/8", 1/4", 1/2", 3/4"
Steel balls	Diam 1/8", 1/4", 1/2", 3/4"
Round stage	Diam 200mm
Other stage	V table (small), stud, diamond stud
JIG tests on long samples	Vari-Rest & Jack-Rest
Micrometric displacement stage for the Jomini tests	Maximum displacement: about 55 mm Mini scale: 1/10mm or 1/160"

## AVAILABLE OPTIONS



Ref. 71133



Ref. 71167

### Standard vices

71133	50mm opening
71199	100mm opening

### Other accessories

71167	Standard Rockwell C test block ø 64 x 15mm
-------	--

# PRESI VIEW & PRESI TOUCH

PRESI View and PRESI Touch softwares have been developed by our engineers around a new generation of digital cameras, to meet the needs of digital imaging laboratories and users.

**Very intuitive**, they handle the acquisition, treatment and editing of images. Thanks to an ergonomic architecture, the software is user-friendly.

Monochrome or color, our digital cameras are equipped with 1/2" CMOS sensors, with Rolling or Global Shutter, depending on the model. Our USB2 1.3 to 5 Mpixels cameras offer excellent **fluidity** and are **easy to install**.

## THE RIGHT SOFTWARE FOR THE RIGHT USAGE

	PRESI View	PRESI Touch
Manual indent analysis	●	●
Automatic indent analysis	●	●
Single indent management	●	●
Multi-language software	●	●
Pattern management		●
Integrated report		●
Hardness tester control		●

Easy learning for the operator: pleasant and easy software interface

Accuracy of measurements

Great work confort and easy data reading

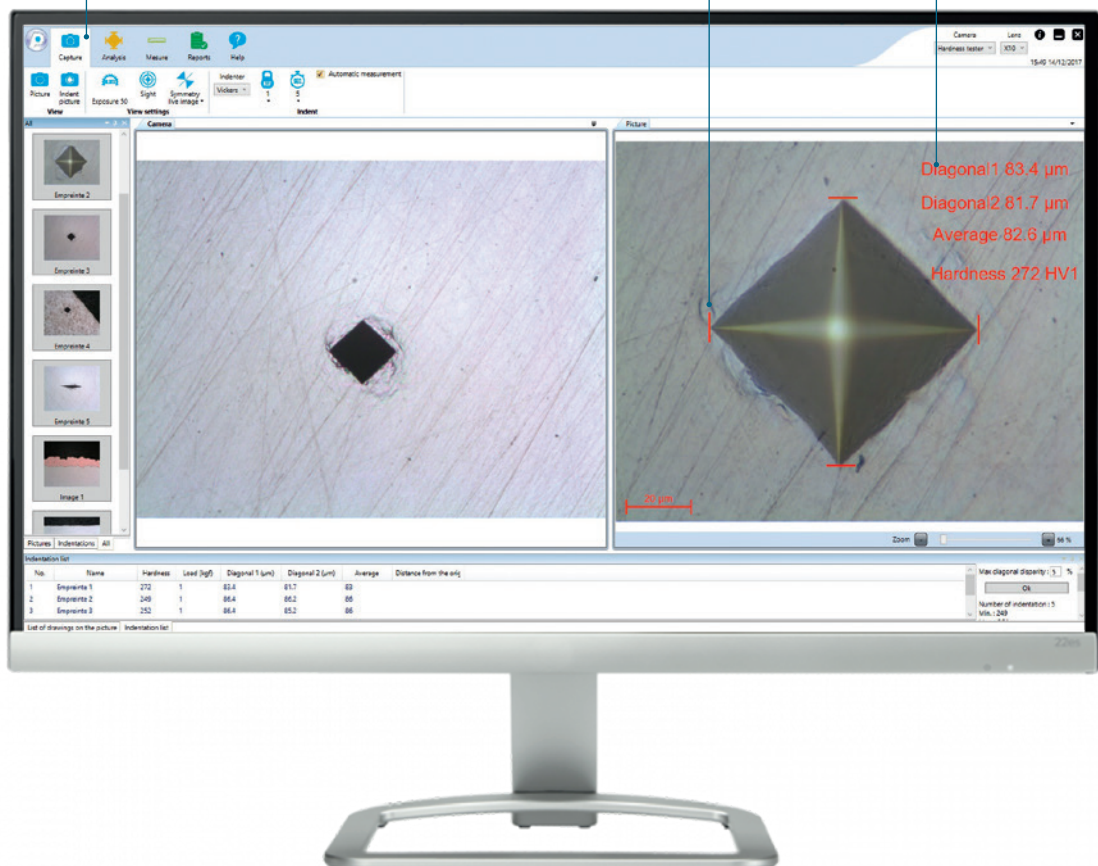

PRESI View - Hardness interface

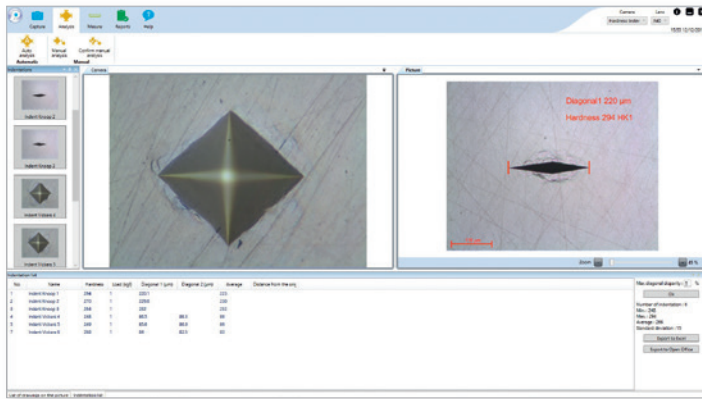

## HARDNESS CONTROL

Image analysis and manual reading.  
Vickers and Knoop measurement.

PRESI View - Full interface

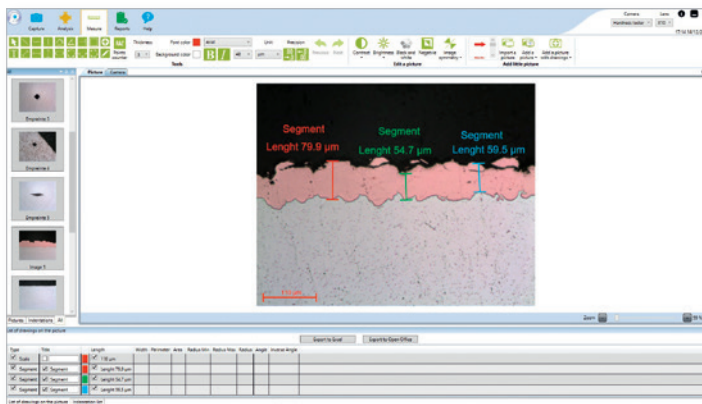

## DIMENSIONAL CONTROL

Length measurements, angles, diameters, surfaces  
on cuts of pieces such as layers painting,  
surface treatments, deposits, etc.

PRESI Touch interface

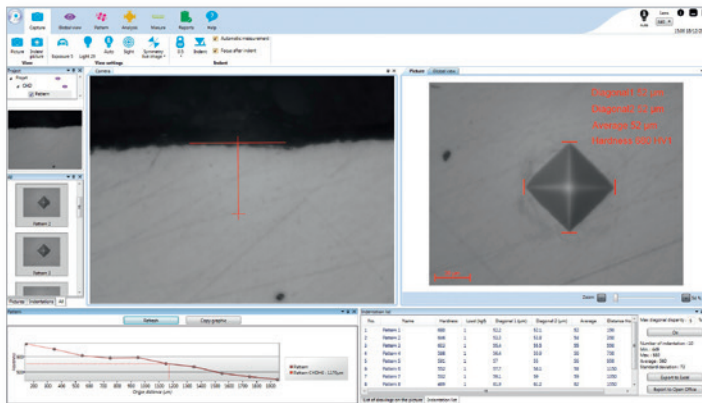

## THERMAL TREATMENT CONTROL

Depth control for heat treatments by direct  
measurement or by using composed measuring tools,  
such as projection.

PRESI Touch interface

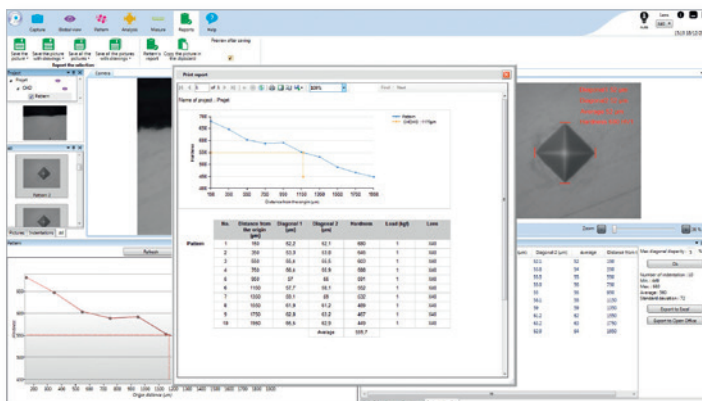

## PRODUCTION CONTROL

Precise, intuitive and fast software for obtaining  
results in production controls.





# PRESI VIEW HARDNESS PACK

## ACCESSIBLE AND INTUITIVE DIGITAL IMAGERY FOR SINGLE INDENTS

Specially designed for single indent analysis, the PRESI View Hardness software has a simple interface and a pleasant workspace. Thanks to easily identifiable icons, the software is user-friendly and the operator is quickly autonomous on his tasks. On-screen visualisation of the indent, as well as the assisted analysis, offer a great work comfort.

### FUNCTIONALITIES

<b>Language</b>	Software available in 3 languages: English + French + German
<b>Indentation type</b>	Single indent
<b>Software</b>	<p>Simultaneous functioning with multiple cameras on different acquisition means (macro lens, stereomicroscope, microscope, hardness tester and Vickers micro hardness tester)</p> <p>Manual or automatic measurement</p> <p>Miniature view of pictures</p> <p>Customizable formatting</p> <p>Streamlined and intuitive interface</p>
<b>Setup menu</b>	<p>Easy and fast camera settings</p> <p>Calibrations achievable in seconds</p> <p>Presets of the measurement display</p>
<b>Exploitation of results</b>	<p>Many recording formats</p> <p>Automatic storage of results in database</p> <p>Pictures exportation in format: JPEG / PNG / BMP / GIF</p> <p>Data exportation in format: Excel / Open Office</p>
<b>Compatibility</b>	The software is compatible with all our Microtech, Macrotech VX7 and VX7S hardness testers, and all brands equipped with a video output and C mount

### EXTENDED FEATURES WITH PRESI VIEW MEASURE

Lengths, thicknesses, markers, angles...

Rays, diameters, perimeters, surfaces, circles, arcs...

Text boxes insertions, titles and arrows

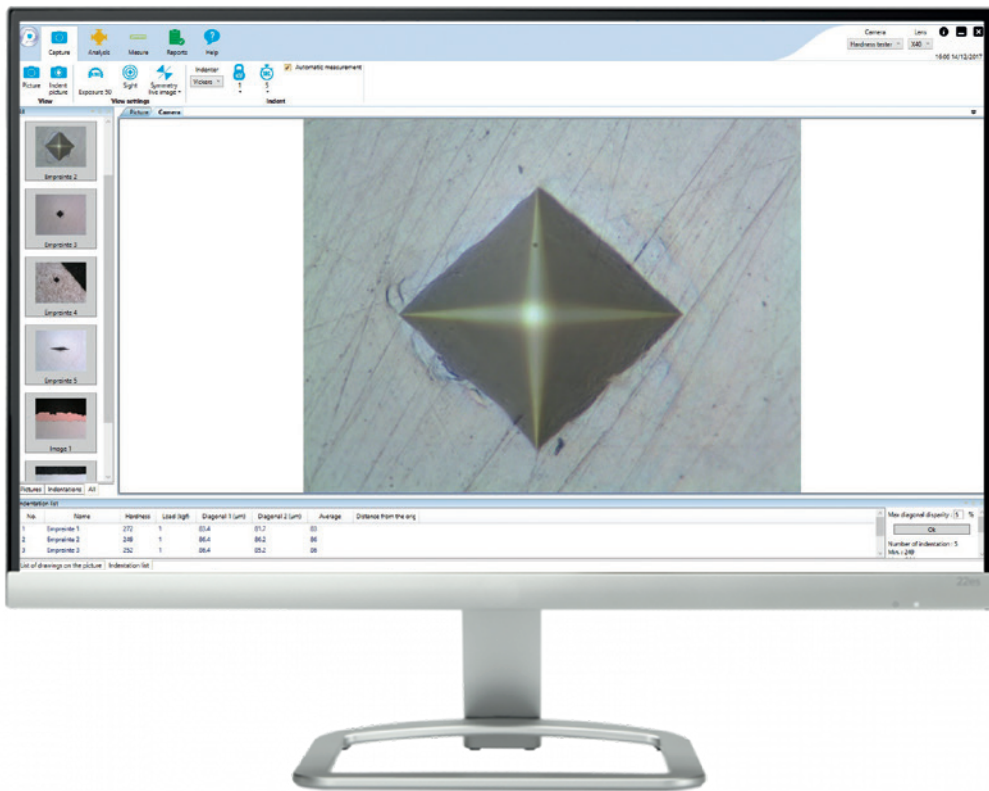

- ◆ EASY AND INTUITIVE
- ◆ IMAGE FLUIDITY
- ◆ AUTOMATIC ANALYSIS
- ◆ DATA STORAGE

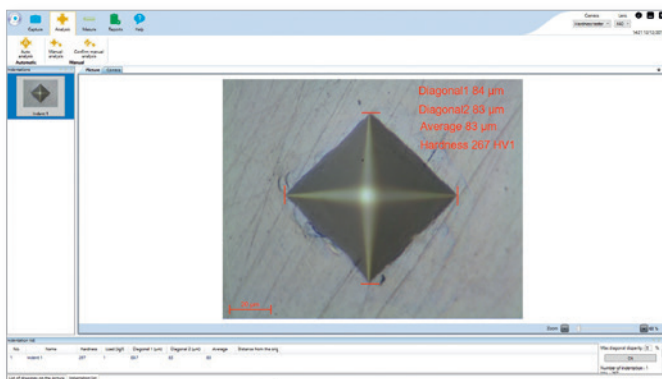

**PRESI View hardness**  
Automatic or manual measurement of Vickers indents.

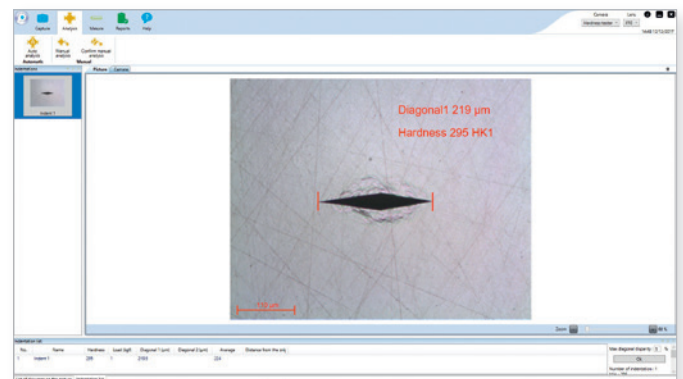

**PRESI View hardness**  
Automatic or manual measurement of Knoop indents.

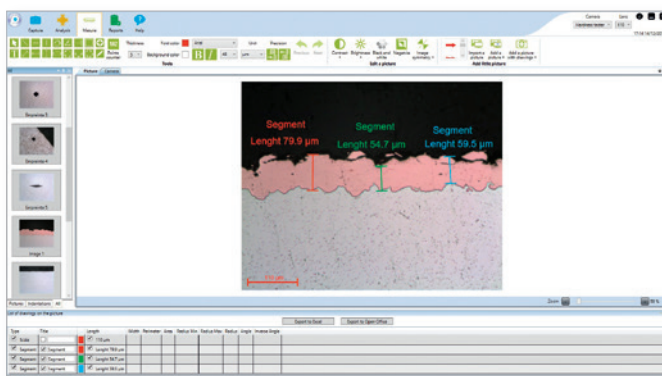

**PRESI View Full**  
The optional measurement module provides a large number of measurement tools such as measuring angles, polygons, projections, etc.

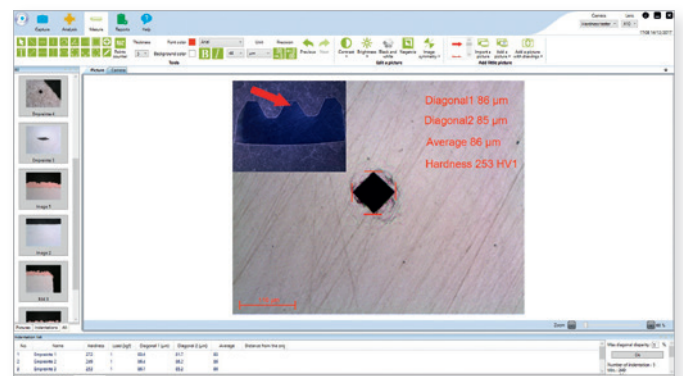

**PRESI View Full**  
The addition of a thumbnail enriches the number of information on a photo. The drafting of the report is thus facilitated.



# PACK PRESI TOUCH MANUAL

## CREATE AND EASILY MANAGE YOUR HARDNESS FILIATIONS

**The PRESITouch Manual Pack** is the 2<sup>nd</sup> level of computerization, allowing the creation and management of hardness patterns. The integrated image analysis in the software allows an easy and reliable interpretation. Designed to facilitate manual patterns and guarantee a perfect repeatability of the results, the PRESI Touch Manual software distinguishes itself by a clear, uncluttered and fully customizable interface. It has numerous features such as automatic measurement or manual indenting. The navigation is simplified, thanks to contextual menus, for a quick start by the operator.

## FUNCTIONALITIES

<b>Language</b>	Software available in 3 languages: English + French + German
<b>Indentation type</b>	Single indent Manual pattern with travel assistant: indication of the coordinates of the moves to be made
<b>Equipment</b>	Measurement and analysis software  USB2 digital camera, 1.3M pixels: the transmitted image on the computer screen is accurate and fluid  Automatic or manual brightness: the software offers an optimal brightness setting on the sample to be analyzed  Turret management: - Manual: the software indicates via pop-up which position to select - Motorized: the software automatically controls the change of position
<b>Features</b>	Automatic or manual measurement: the operator can choose to let the PRESI Touch software automatically analyze the indents, or manually perform the interpretation  Automatic storage of results and photos into the database  Search engine: allows you to quickly find already completed projects  Pattern settings: graphical and dynamic menu, allowing real time monitoring of the programming  Hardness tester / PC communication: the operator can control and interact directly with the hardness tester via the software  Difference of load alert: in case of a difference between the programmed load via the software and the manually defined load by the operator, an alert pops up on screen  Analysis reports: numbers, graphs and statistics can be exported in one click in Word, Excel or PDF formats
<b>Compatibility</b>	PRESI Touch Manual software is compatible with all Microtech, Macrotech VX7 and VX7S hardness testers

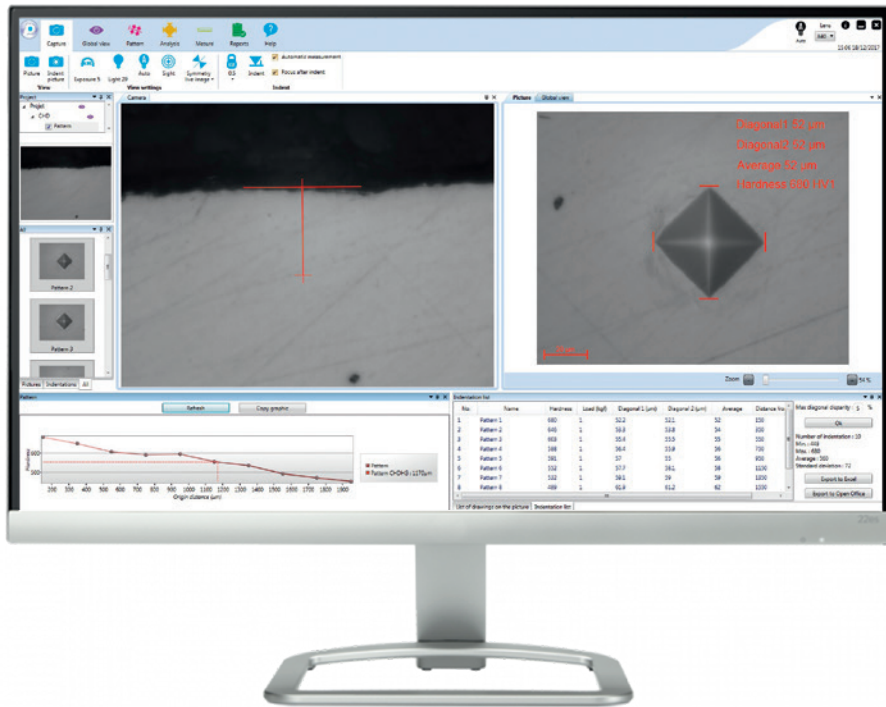

- ◆ INTEGRATED MEASURING TOOLS
- ◆ PRECISION AND REPEATABILITY OF MEASUREMENTS
- ◆ GREAT WORK COMFORT AND EASY DATA READING
- ◆ USER-FRIENDLY SOFTWARE

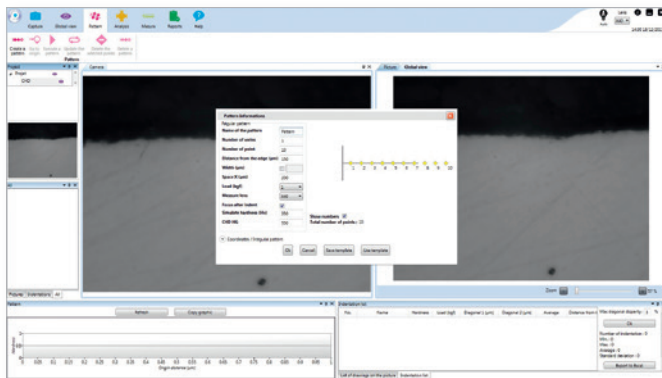

### Pattern creation

A graphic and dynamic assistant allows pattern visualisation during its programming.

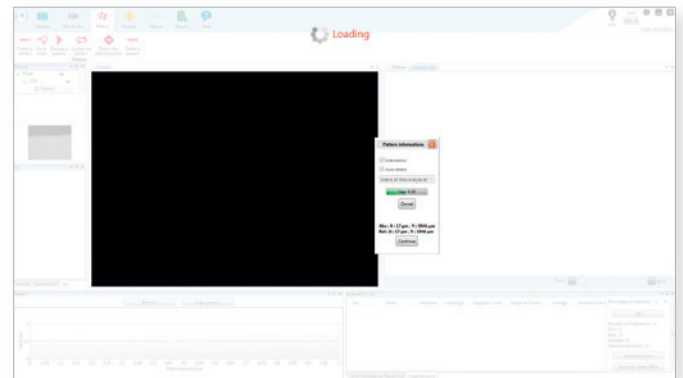

### Pattern execution

The operator is guided by the software. XY coordinates of the indentations to perform are shown on the screen.

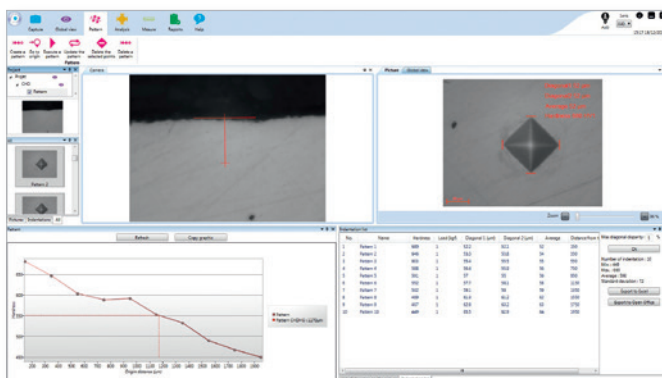

### Interface

The fully configurable interface allows the visualization of all results, regardless of the selected function.

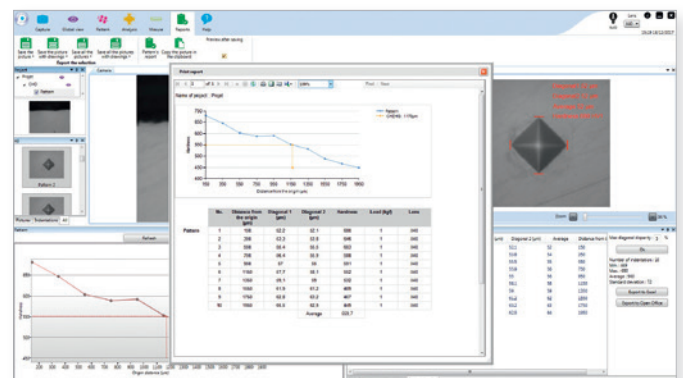

### Automatic report

In one click, a report formats the results. This report is printable or recordable in many formats.



# PACK PRESI TOUCH SEMI-AUTO

## THE XY AUTOMATIC DISPLACEMENT SERVING YOUR PATTERNS

Developed in an effort to optimize efficiency and to free the user from tedious operations and increase productivity, **the Semi-Auto Pack** incorporates a motorized stage, driven by joystick.

Its XY automatic displacement accuracy offers real time saving, repeatability and guarantees consistency in the interpretation of the results. PRESI Touch pattern storage facilitates the operator's work. The software allows pattern creation in no time and instant editing of a hardness profile.

Easy and automatic measurements, ideal for serial checks.

### FUNCTIONALITIES

<b>Language</b>	Software available in 3 languages: English + French + German
<b>Indent type</b>	Single pattern Semi-automatic pattern
<b>Equipment</b>	Multilingual software for measurement and image analysis  USB2 digital camera, 1.3M pixels: the image retransmitted on the computer screen is accurate and fluid  Automatic or manual brightness: the software offers an optimal brightness setting on the sample to be analyzed  Control box, motorized stage and joystick: a set of peripherals allowing fast and precise movements on the surfaces to be analyzed
<b>Features</b>	Manual or automatic measurement: the operator can choose to let the PRESI Touch software automatically analyze indents or manually manage the control  Pattern settings: graphical and dynamic menu, allowing real time monitoring of the programming  Hardness tester / PC communication: the operator can control and interact directly with the hardness tester via the software  Overview: possibility to photograph all or part of the sample to be analyzed and to directly place the patterns in the right places  Deformed indent alert: a colored line appears in the result table when $d1 = d2 \pm x\%$ (adjustable tolerance)  Difference of load alert: in case of a difference between the programmed load via the software and the manually defined load by the operator, an alert pops-up on screen  Analysis reports: numbers, graphs and statistics can be exported in one click in Word, Excel or PDF formats  Image analysis: automatic or manual indent analysis on etched or non-etched samples  Single indents, regular or irregular patterns: in order to meet numerous needs, the software allows the execution of isolated points, the programming, the backup and the loading of a pattern or of a set of patterns
<b>Compatibility</b>	The PRESI Touch Semi-auto software is compatible with all our Microtech, Macrotech VX7 and VX7S hardness testers



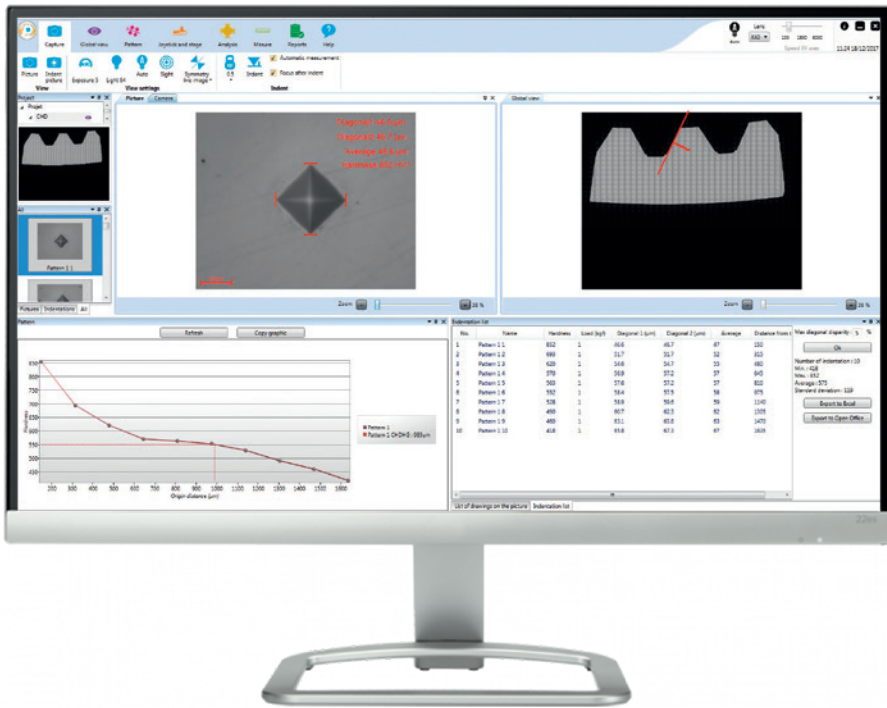

- ❖ COMPLETE, RELIABLE AND POWERFUL
- ❖ VERY HIGH QUALITY IMAGE
- ❖ INTUITIVE NAVIGATION
- ❖ TIME SAVING

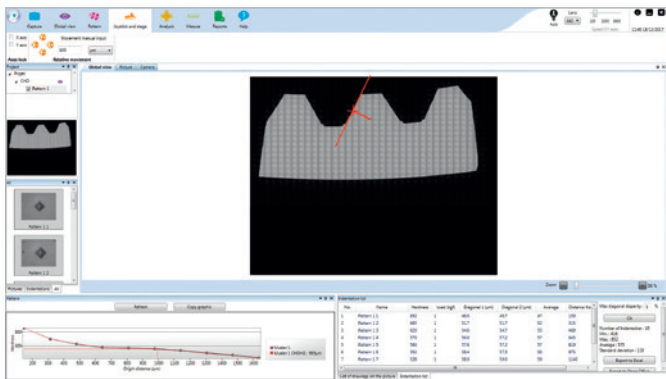

**Overview**  
The motorized stage makes it possible to reconstruct, by photos, the sample to be analyzed.

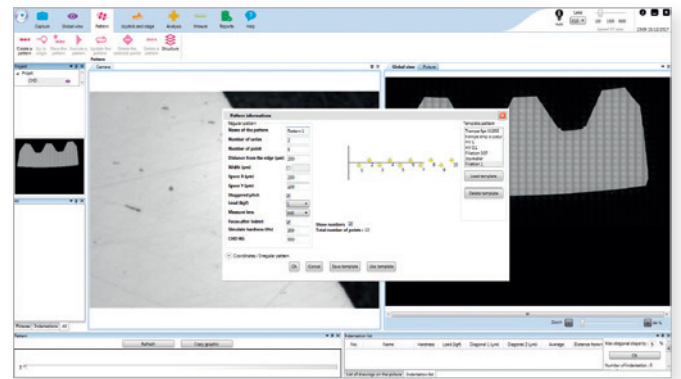

**Programmation**  
A graphic and dynamic assistant allows pattern visualisation during its programming. It is possible to place the pattern directly on the overview.

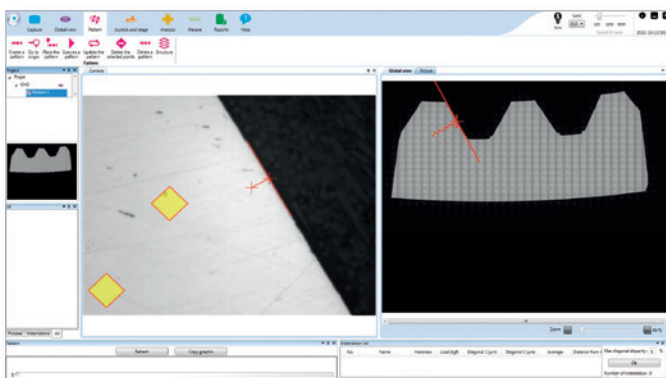

**Virtual pattern**  
Once the pattern is programmed, it virtually appears on the camera view. It is possible to visualize the location of the different indents, as well as their estimated size.

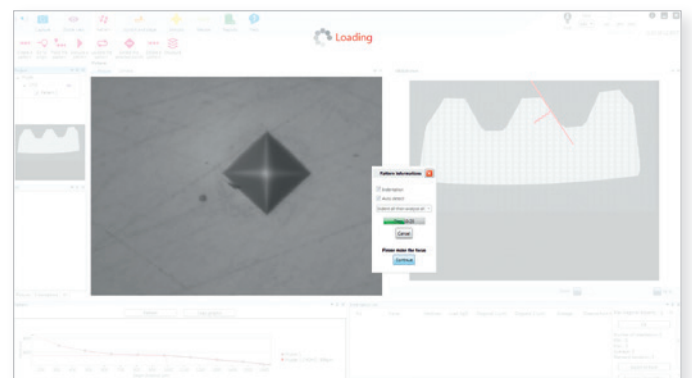

**Measuring cycle (automatic or manual)**  
A pop-up window asks the operator to check the focus of the indent, before measurement.

# MICROTECH MX3 - MX7 - MX7 LOW LOADS

PACK

PRESI VIEW  
HARDNESS

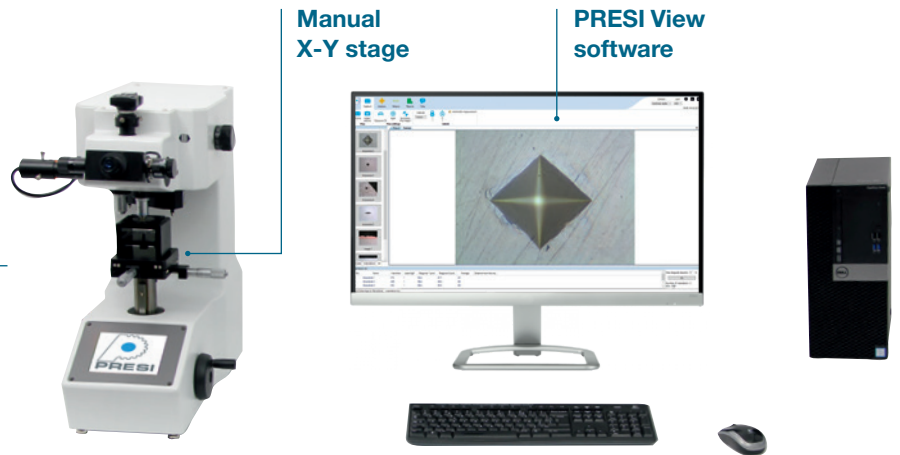

PACK

PRESI TOUCH  
MANUAL

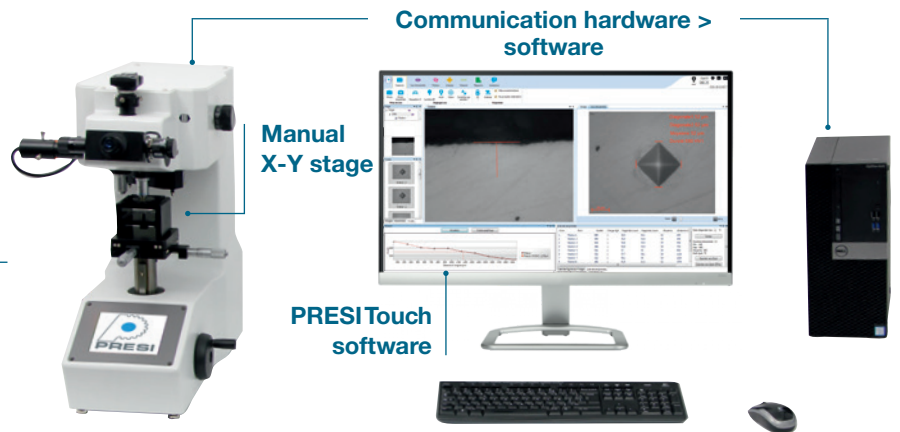

PACK

PRESI TOUCH  
SEMI-AUTO

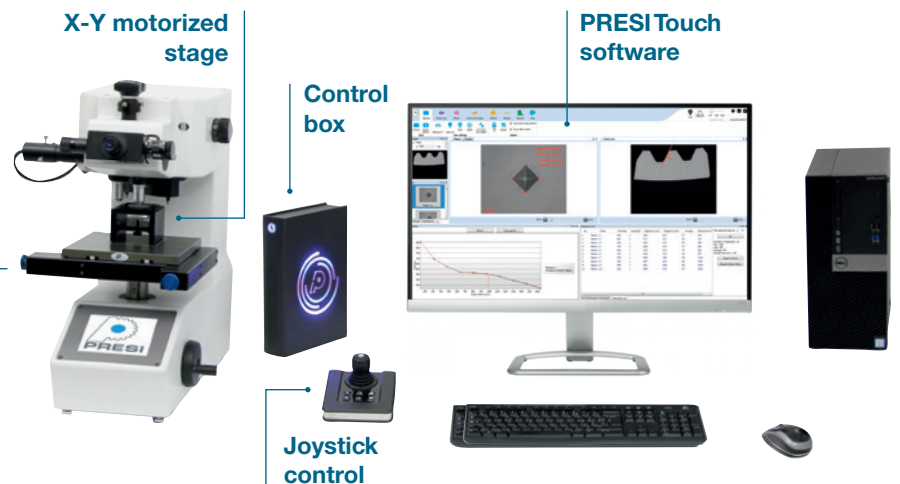

# MACROTECH VX7- VX7S

PACK

## PRESI VIEW HARDNESS

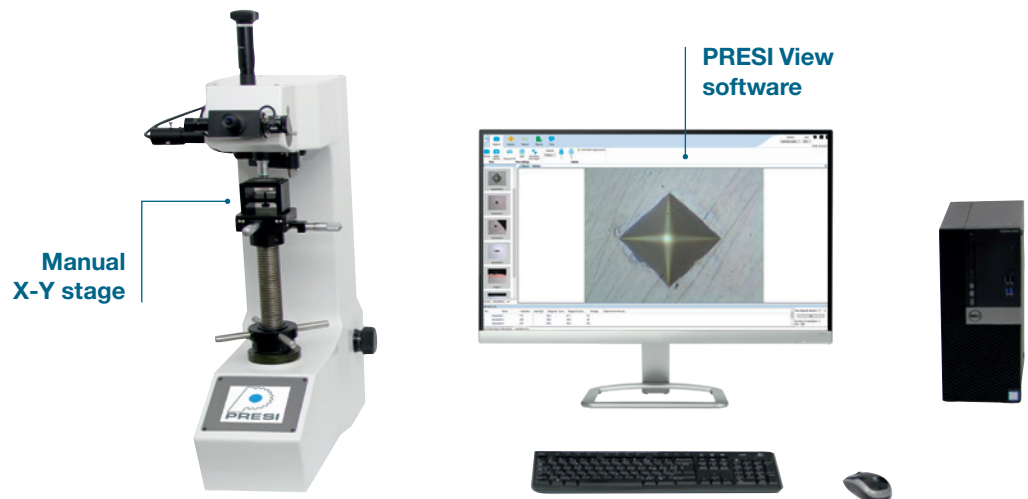

PACK

## PRESI TOUCH MANUAL

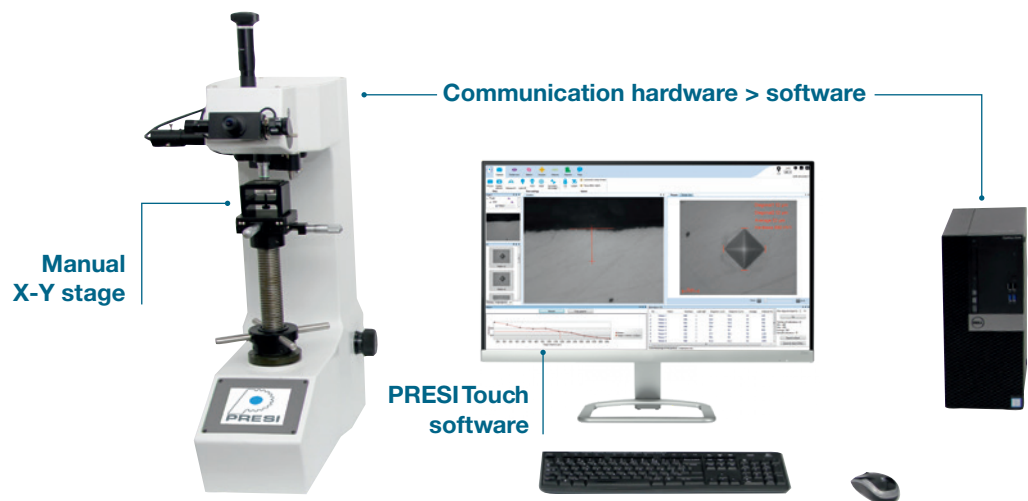

PACK

## PRESI TOUCH SEMI-AUTO

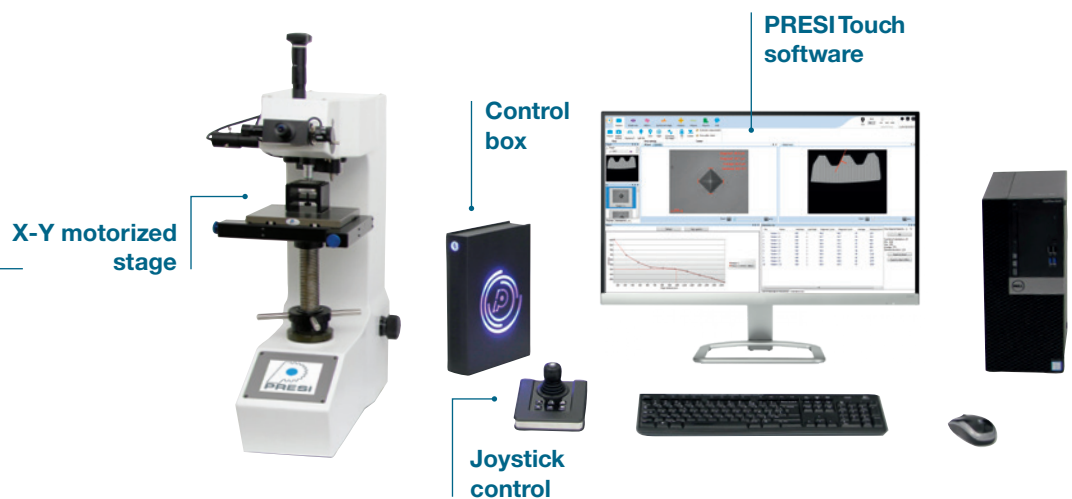

[WWW.PRESI.COM](http://WWW.PRESI.COM)

